



W57 series

Compact, Push To Reset Only P&B Thermal Circuit Breaker



Features

- New, compact design.
- 3 to 20 amp ratings.
- Cannot be manually tripped.
- Button extends for visual trip indication.
- Push button to reset breaker.
- Numerous mounting and termination options.
- Optional bottom marking of amperage rating.

Agency Approvals

W57 series is UL1077 Recognized as Supplementary Protectors, File E69543, for Canada and the United States. Available models meet Ignition Protection requirements in accordance with UL1500. Approved to VDE 0642/EN60934 (Circuit Breakers for Equipment) License Number 40007874 (excludes models rated 3-4A and >15A). CCC mark compliant, certificate 2004010307123217.

Users should thoroughly review the technical data before selecting a product part number. It is recommended that users also seek out the pertinent approvals files of the agencies/laboratories and review them to confirm the product meets the requirements for a given application.

Electrical Data @ 25°C

Calibration: Will continuously carry 100% of rating. May trip between 101% and 134%, but must trip at 135% of rating within one hour at +25°C.

Dielectric Strength: 1,500VAC (60 seconds).

Insulation Resistance: 100 megohms.
Maximum Operating Voltages: 50VDC; 250VAC, 50/60 Hz.
Interrupt Capacity: 1,000 amps in accordance with UL standard 1077.
Resettable Overload Capacity: Ten times rated current.
Reset Time: 60 seconds.

Typical Resistance vs. Current Rating @ +25°C

Current Rating in Amps	Typical Resistance in Ohms	Current Rating in Amps	Typical Resistance in Ohms
3.0	0.083	8.0	0.031
4.0	0.062	10.0	0.025
5.0	0.050	12.0	0.021
6.0	0.042	15.0	0.017
7.0	0.036	20.0	0.012

Mechanical/Environmental Data

Operating Temperature Range: 0°C to +60°C.
Termination: .250" (6.35mm) quick connects.
Mounting: Various options. See Ordering Information and drawings.
Approximate Weight: 0.5 oz. (14.3g).

Time vs. Current Trip Curve @ +25°C



Outline Dimensions

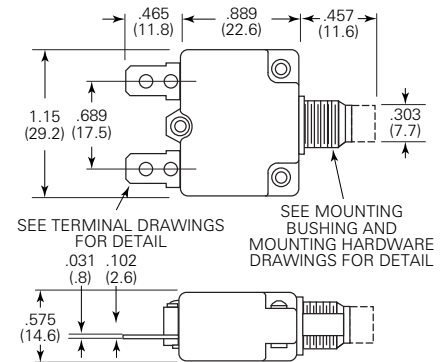

Optional Protective Boot

Silicone rubber boot is bonded to integral aluminum nut.

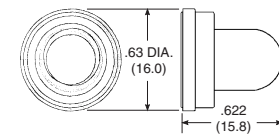

1-1423696-5
Black boot for W57 with 3/8"-24 bushing.

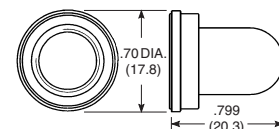

1-1423696-6
Clear boot for W57 with M11 X 1.0 bushing.

Ambient Compensation Table

Ambient Temperature in °C	Rating Correction Factor	
	3-4A Models	5-20A Models
-10	.70	.77
0	.75	.85
10	.82	.90
20	.90	.95
25	1.00	1.00
30	1.10	1.05
40	1.25	1.15
50	1.61	1.25
60	2.15	1.40

To use this chart: Divide the breaker rating by the correction factor to determine the compensated rating. Calculate the overloads in terms of the compensated rating to use the published trip curve. Do not use these devices outside their specified operating temperature ranges.

Ordering Information

Typical Part No. >	W	57	-X	B	1	A	4	A	1	0	-4
1. Designator: W = Circuit breaker											
2. Series Number: 57 = Compact, Single Pole, Push-to-Reset, Thermal Model											
3. Circuit Function: X = Series Trip											
4. Button Color & Rate Marking: A = White, plain, no rate marking B = White, red rate marking (vertical) C = White, black rate marking (vertical) D = Black, plain, no rate marking E = Black, white rate marking (horizontal) F = White, red rate marking (horizontal) G = White, black rate marking (horizontal) H = Black, white rate marking (vertical) I = Red, plain, no rate marking J = Black, no rate marking on button, white rate marking on bottom of case between terminals.											
5. Mounting Bushing: 1 = Plastic, 9.8mm (double D) X 9.6mm long, M11x1 threads, (similar to 7/16"), hex base 2 = Plastic, 3/8" (single D) x 10.5mm long, 3/8"x24 threads, hex base 4 = Plastic, snap-in type 5 = Metal, 9.8mm (double D) X 9.6mm long, M11x1 threads, (similar to 7/16"), round base 6 = Metal, 3/8" (single D) x 10.5mm long, 3/8"x24 threads, hex base 7 = Metal, 10.8mm (double D) x 9.6mm long, M12x1 threads, (similar to 15/32"), round base 8 = Metal, 3/8" (double D) x 10.0mm long, 3/8"x24 threads, hex base Notes: Codes 1 and 3 are similar in size to 7/16" bushings (not exact equivalent). Code 7 is similar in size to a 15/32" bushing (not exact equivalent)											
6. Terminals: (see drawings for detail) A = Quick connect .250" (6.35mm) straight B = Quick connect .250" (6.35mm) , bent 90° C = Quick connect .250" (6.35mm) , bent 45° D = Quick connect .250" (6.35mm) , bent 90° E = Quick connect .250" (6.35mm) , bent 90°, PCB compatible F = Quick connect .250" (6.35mm) , bent 90°, PCB compatible G = Quick connect .250" (6.35mm) , straight (smaller hole) H = One quick connect .250" (6.35mm) , one #8-32 screw bent 90° I = Same as F above, but amperage marking reversed.											
7. Mounting Hardware: 4 = Metal knurled nut/hex nut 6 = Metal hex nut 12 = Metal knurled nut 15 = 2 metal hex nuts, metal lockwasher 18 = Metal hex nut, metal lockwasher 7 = Plastic knurled nut 8 = Plastic knurled nut with small hole 22 = Plastic knurled nut, metal lockwasher 99 = None											
8. Mounting Hardware Packaging: A = Assembled to bushing B = Bulk unassembled C = No mounting hardware.											
9. Maximum Operating Voltage (AC): 1 = 250VAC 2 = 125VAC/50VDC											
10. Nameplate: 0 = None 1 = Embossed aluminum 2 = Silver color printing on black color 3 = Black color printing on silver color											
11. Specify Amp Rating: 3† 4† 5 6 7 8 10 12 15 20† †Not VDE											
12. UL Recognition: Leave Blank = UL1077 recognized breaker M = Model meeting Ignition Protection requirements in accordance with UL1500, in addition to UL1077 recognition† †Not VDE											

Our authorized distributors are more likely to stock the following items for immediate delivery.

W57-XB1A4A10-5 W57-XB1A4A10-15 W57-XB1A5A10-5 W57-XB1A5A10-15
W57-XB1A4A10-10 W57-XB1A4A10-20 W57-XB1A5A10-10 W57-XB1A5A10-20

ORDERING NOTE: Mounting hardware can be ordered separately. Some options are subject to extended leadtimes and significant minimum order quantities.

Mounting Bushings and Recommended Panel Cutouts



Termination Options



Option A
.250 QC
Straight



Option C
.250 QC
45°



Option D
.250 QC
90°



Option E
.250 QC/PCB
270°



Option B
.250 QC
90°



Option F or I
.250 QC/PCB
270°



Option G
.250 QC Straight
(small hole)



Option H
.250 QC Straight
with #8-32 Load
Term. Bent 90°

Mounting Hardware Options

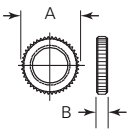

Knurled Nut



Hex Nut



**Integrated Knurled Nut
with Small Holes**

ALTERNATE TEETH TWISTED
IN OPPOSITE DIRECTIONS

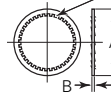

Lockwasher

Optional Bottom Marking of Rating



Mounting Hardware Dimensions

Dimension Code	Bushing Diameter	Plastic Knurled Nut	Integrated Plastic Knurled Nut w/Holes	Metal Knurled Nut	Metal Hex Nut	Lockwasher
A	3/8"	.74 (18.8)	-	.56 (14.2)	.55 (14.0)	.49 (12.5)
	M11	.74 (18.8)	.74 (18.8)	.59 (15.0)	.55 (14.0)	.587 (14.9)
	M12	-	-	.59 (15.0)	.55 (14.0)	.626 (15.9)
B	3/8"	.126 (3.2)	-	.079 (2.0)	.079 (2.0)	.02 (.5)
	M11	.126 (3.2)	.13 (3.3)	.102 (2.6)	.118 (3.0)	.02 (.5)
	M12	-	-	.102 (2.6)	.079 (2.0)	.02 (.5)

Mounting Hardware Ordering Information

Mounting Bushing Material	Mounting Bushing Code	Plastic Knurled Nut	Integrated Plastic Knurled Nut w/Holes	Metal Knurled Nut	Metal Hex Nut	Lockwasher
Plastic	1 (M11)	-	1423696-8	2-1423696-2	-	-
	2 (3/8")	-	1423696-2	-	-	-
Metal	5 (M11)	-	-	1423696-4	1423696-6	1-1423696-2
	6 (3/8")	-	-	1-1423696-0	1423696-3	1-1423696-1
	7 (M12)	-	-	1423696-5	1423696-7	1-1423696-3
	8 (3/8")	-	-	1-1423696-0	1423696-3	1-1423696-1

Nameplates

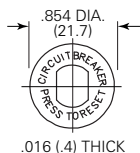

.016 (.4) THICK

Embossed Aluminum

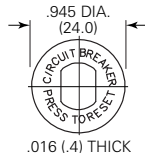

.016 (.4) THICK

**Imprinted Aluminum
(Either Silver on Black
or Black on Silver)**